

**OPERATION MANUAL
FOR**

Robot*  *Coupe[®]

MODELS

[®]BLIXER 5

[®]BLIXER 6

- I. INTRODUCTION**
- II. ASSEMBLY/DISASSEMBLY INSTRUCTIONS**
- III. OPERATING INSTRUCTIONS**
- IV. PREVENTIVE MAINTENANCE GUIDE**
- V. TROUBLE SHOOTING AIDS**

**ELECTRICAL SCHEMATIC
PARTS DIAGRAMS AND PARTS LISTS
SERVICE AGENCY LISTING**

robot coupe U.S.A., Inc.
P.O. Box 16625, Jackson, MS 39236-6625
280 South Perkins St., Ridgeland, MS 39157
email: info@robotcoupeusa.com
website: www.robotcoupeusa.com
1-800-824-1646

September 2004

IMPORTANT NOTICE

3-PHASE MOTORS DRIVE SHAFT ROTATION

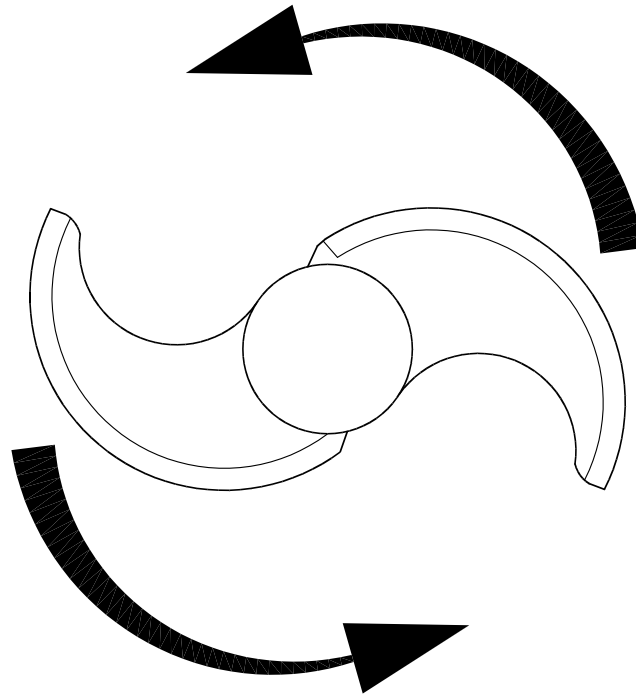

Three phase motors may rotate either direction. The required motor rotation is counterclockwise. Check the rotation before attaching the cutter blades. Changing the motor rotation requires a qualified electrician. Also, see the note attached to the end of the power cord.

CAUTION:

Always connect the Robot Coupe to a grounded outlet with Ground fault circuit interrupter (GFCI) protection device.

Disconnect the machine from the power outlet when not in use and when cleaning or servicing the unit.

Machine must be operated and stored in a location not subject to water drips or spray or explosive vapors.

The machine must not be modified in any way from its original configuration.

Should the machine malfunction or should any part be damaged, it must not be operated until it is repaired by a qualified technician using only genuine Robot Coupe® repair parts.

Operating times of 5 minutes or longer can cause processed food to increase to temperatures above 125 F.

Failure to follow operating instructions or attempts to operate the machine outside its design limits may create a hazardous condition that could damage the machine and /or injure users.

The machine must be operated on a clean sturdy counter or table. Keep the area around and under the machine clear to allow air circulation. Otherwise, the motor can overheat.

I. INTRODUCTION

The Robot Coupe commercial food processor performs a host of culinary feats. It is specifically designed for high speed and quality processing. The Robot Coupe also provides a wealth of safety and operating features to make volume food preparation a pleasure rather than a chore.

The operators manual is designed to guide the user through the simple steps of use for a safe, long life utilization. The manual should be referred to any time there is a question on operation. **THIS MANUAL SHOULD BE KEPT WITHIN EASY ACCESS TO ALL USERS FOR REFERENCE, AND SHOULD BE READ COMPLETELY BY ALL FIRST TIME USERS OF THE MACHINE.**

CAUTION: Your Robot Coupe comes with a sharp cutting blades. Always handle with **safety** in mind. **WEAR CUT-RESISTANT GLOVES WHEN HANDLING THE BLADES.**

NOTICE: If the machine fails to operate as described in this manual, or if the machine malfunctions in any way, remove the machine from use and have it serviced. **DISCARD ALL FOOD PROCESSED AT THE TIME OF THE MALFUNCTION.**

Machine specifications:

The **Models ®Blixer 5 and ®Blixer 6** are equipped with a high speed motor generating 2 HP which plugs into a standard 208/240 volt/60HZ power outlet. The full load amperage rating is 5.3 amps on low speed and 5.8 amps on high speed. The machines are supplied with a stainless steel bowl: the Blixer 5 with a 5 1/2 quart and the Blixer 6 having a 7 quart bowl. Both machines are supplied with S-blade and clear polycarbonate cover. A bowl and lid wiper assembly is supplied with removable handle.

II. ASSEMBLY / DISASSEMBLY INSTRUCTIONS

A. Assembly

STEP 1. Facing the front of the motor base (see drawing), locate the bowl handle at the upper left corner of the motor base. With the bowl fully seated and level with the motor base, twist counter clockwise, until the bowl locks in place. The handle should be centered over the front of the motor base.
NOTE: The machine will not operate correctly unless the bowl and lid are fully seated and locked in place.

STEP 2. Place the “S” blade on the motor shaft and turn until the blade drops down. When the “S” blade is in the correct position the lower blade should be resting just off the bottom of the bowl.

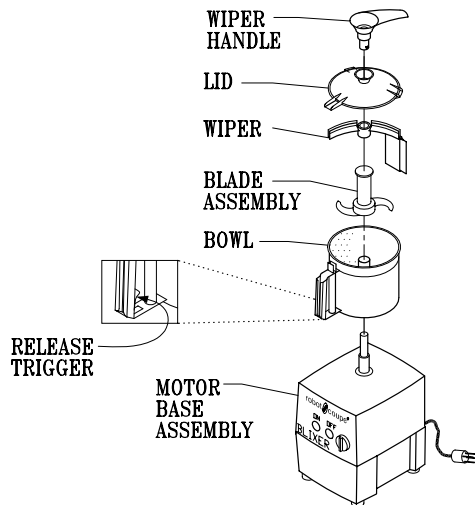

STEP 3. Insert the wiper assembly handle into the opening in the top of the lid. Using both hands, align the tabs on the handle with the indentations on the wiper. Press in and turn clockwise.

STEP 4. With the wiper assembly in place put the lid on the bowl. Note the three extensions on the lid. One is longer with an arrow pointing to the right. Locate this extension just to the left of the bowl handle. Then, with the lid fully seated, turn the lid counter clockwise until it comes to a complete stop.

B. Disassembly of the Cutter Bowl Attachment

STEP 1. Turn the machine **OFF** and **UNPLUG** the power cord from the wall socket.

STEP 2. Rotate bowl lid clockwise and lift off.

STEP 3. Remove the blade assembly.

STEP 4. Locate the release trigger on the lower back portion of the bowl handle. Pull the trigger and at the same time, turn the bowl clockwise and lift free.

E. Blade Assembly/Disassembly

Disconnect the power supply and wear cut-resistant gloves!

®Blixer 6

1. Unplug the cord, and wear cut-resistant gloves!

2. Put the blade tool down over the motor shaft with the raised stop facing the front of the machine.

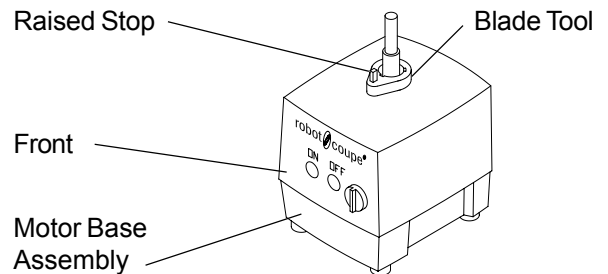

3. Put the blade on the motor shaft so that the center of the blade assembly rests flat on the blade tool.

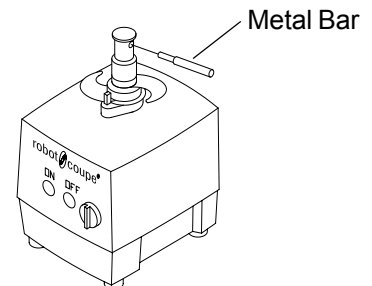

4. Insert the metal bar into one of the holes in the blade cap.

5. Turn the blade cap clockwise to tighten or counterclockwise to loosen. The bottom blade should hit the stop on the blade tool and prevent the assembly from turning. Do not overtighten.

Continued

®Blixer 5

There is a **removable cap** in the top of the ®Blixer 5 Blade. The cap should be removed before cleaning. To remove the cap, push a long blunt object such as a screwdriver, through the bottom of the blade, and knock out the top cap.

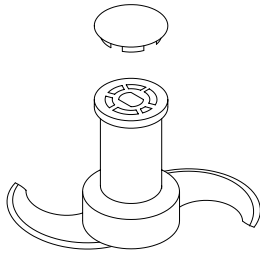

®Blixer 6

Assemble as shown, with the small nylon spacer directly under the top locking nut.

The bottom blade should be installed beveled side up and the top blade beveled side down.

Lubricate the threads with a food-grade grease before reassembly.

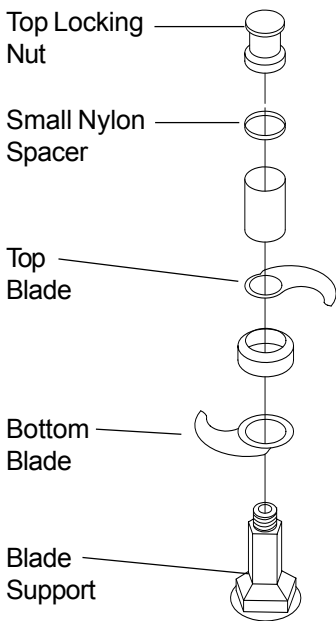

THE BLADE ASSEMBLY ON THE BLIXER 5 AND BLIXER 6 SHOULD BE TAKEN APART AND CLEANED AT LEAST ONCE A DAY.

APPLY SOME FOOD-GRADE GREASE OR OIL TO THE BLIXER 6 ASSEMBLY TO EASE DISASSEMBLY.

III. OPERATING INSTRUCTIONS

DO NOT ALLOW THE MACHINE TO RUN UNATTENDED.

With the power switch OFF and the bowl and blade secured in place (per previous instructions) you are now ready to add product to the bowl. Place the product in the bowl not over 3/4 full and rotate the cover to secure it in place. There are two ways to run your unit. First of all, you may run the unit continuously by filling the bowl with food and simply letting it run or process until the desired consistency has been reached. Use this method to grind, mix, blend, puree, or emulsify. Secondly, you may chop with your unit by pulsing the machine. Quickly start and stop the motor by alternately pressing the ON and OFF switches. The reason for this is that you want the lower blade to pick up the product and throw it into the air allowing the top blade to chop the product. Control and consistency can be better achieved in this manner. Remember, if you start with a consistent product your end product will also be consistent. Most operations should be run on Low speed, using High speed only when an extremely fine pureed consistency is desired.

TO CHOP: (Low Speed) Cut round vegetables into halves or quarters and prep long vegetables into 3 to 4 inch pieces. To achieve a chopped consistency for vegetables, cheese, meats, etc. fill the bowl with the product no more than 3/4 full. With the lid secured, and the speed selector in Low speed, alternately press the ON/OFF buttons. Repeat this pulsing action, allowing the blades to stop each time, until the desired cut is achieved. Usually 4 to 5 pulses yields an evenly mixed chopped substance.

TO PUREE OR MIX: Fill the bowl with the product no more than 3/4 full. Start the machine in Low speed and allow to run until the product is completely reduced. If necessary, turn the machine off and select High speed to finish the product. It may be necessary to add some liquids to a puree to achieve the desired consistency.

DOUGHS AND PASTRIES: (Low speed only) In many cases it may be helpful to first mix all dry products then add the liquids. The unit should be run continuously until the product is completely processed. For thick doughs, such as for pizza, the machine will form a ball of dough when the mixing is complete. When a ball is formed, the machine should be turned off immediately to prevent over-processing. Preparation times and all ingredients should be noted for different recipes.

TO CHOP MEAT: (Low Speed) Place chunks of meat approximately 1 to 2 inches square in the bowl. Fill approximately 1/3 to 1/2 full (no more than 2 1/2 lbs). Rotate the lid locking it in place, quickly start and stop the motor using the ON/OFF switches. Repeat this process until product is the desired consistency.

TO CHOP HARD CHEESE: (Low speed only) Place chunks of well chilled cheese into the bowl (not over 2 1/2 lbs). With the lid locked in place, quickly start and stop the motor. Continue this process until you have reached the desired consistency. For powdered cheese, simply proceed as above until the particles in the bowl are about pea size, then start the unit and allow the blades to run continuously until you have a fine powder.

TO CHOP ONIONS, CELERY, CABBAGE, CARROTS, ETC.: Quarter onions, and cut other vegetables into 2 to 3 inch pieces. Proceed using a quick start\stop action until the desired consistency is achieved. **CAUTION:** If you turn the machine on with vegetables in it and let it run too long, the bottom blade will puree the ingredients and the top blade will be of little value leaving a very uneven consistency.

TO PUREE OR MIX: To puree tomatoes, make sauces, or to mix and blend, place the ingredients in the bowl, turn the unit on and allow it to run continuously until the product is rendered to the desired consistency.

TO MAKE MAYONNAISE: Place in the bowl 6 eggs, 3 tsp. of salt, 3 tsp. of sugar, 2/3 tsp. of dry mustard, a pinch of white pepper, and a pinch of red pepper. Turn the unit on. Begin adding 2 qts. of oil pouring very slowly through the top allowing the stream of oil to fall on the top of the cutter blade. When you have added 1/2 of the oil, pour in 4 oz. of vinegar and the balance of the oil. After all of the oil has been added let the machine run for 20 seconds longer. The mayonnaise is now homogenized.

TO MAKE BREAD CRUMBS: Place torn fresh or dried bread in the bowl, and quickly start and stop the unit. Continue this process until you reach the desired consistency or allow the unit to run continuously for fine powdered bread crumbs used in stuffing mix.

CAUTION: Always allow the blades to come to a complete stop before removing the lid.

GENERAL HINTS

1. Be sure your Robot Coupe machine is properly assembled before using.
2. Always insure blade and attachment are tightly in place.
3. Do not fill the cutter bowl over 3/4 full.
4. Learn to operate the cutter bowl using a start\stop motion so the consistency of the prepared product can be controlled. Remember it is important to start with uniform pieces for uniform results.
5. Wash the bowl, blade, and cover after every use. Do not store food in the bowl.
6. If the motor does not start when the switch is on and the lid is fully in position, disengage the lid (machine is now off) and check to see if the attachment is locked in place. If okay, unplug the unit and see if any food is jamming the blade.
7. If the machine malfunctions for any reason, discard any food being processed at that time.

IV. PREVENTIVE MAINTENANCE/TROUBLE SHOOTING AIDS

The Robot Coupe has been designed to provide maximum trouble free performance. Adherence to the assembly and operating instructions will further assure good performance. Additionally, if simple common sense rules are applied to the unit, a long life utilization will be achieved.

(1) Care: While the Robot Coupe is a ruggedly constructed machine, overall handling should be accomplished with a sense of use rather than abuse. The continuous feed attachment and the motor housing are made of rugged cast aluminium and will yield a long life if not maltreated. While the machine is reasonably portable, care should be taken not to drop it. Remove the continuous feed and any plates or other attachments before relocating the machine. Your Robot Coupe should never be picked up by the bowl or the cord. Always lift from the bottom of the motor base assembly. Care should be exercised in relocating it. Equal caution should be exercised in handling all of the parts to assure they are not subject to undue force.

(2) Cleaning: Proper cleaning of the machine is one of the MOST IMPORTANT preventive maintenance measures the user can employ. The high acid content of food can cause harm to electrical parts contained within the housing. Although these elements are isolated from the outside through seals, vegetable juices will tend to seep. If vegetable juices are permitted to collect on the machine over periods of use, erosion of the seals can occur. It is recommended that the machine be cleaned after each operational use, and minimally once per day.

The blade assembly should be taken completely apart and washed after each days use. This will prevent the parts from becoming jammed or "freezing up" and is required for sanitary purposes. Follow the previous assembly/disassembly instructions carefully, and **wear cut-resistant gloves when handling the cutting blades.**

Correct cleaning procedures are required to assure that damage is not inflicted in the cleaning process. The motor support/base assembly contains the motor and electrical components.

DO NOT IMMERSE THE MOTOR BASE ASSEMBLY IN WATER

Cleaning of the motor/base assembly must be done with care. First, unplug the unit. A sponging with a soluble detergent is acceptable, making sure the water is not permitted to penetrate the seals. Clean around the seals with a small brush, taking care to remove all food. Do not forget to clean the motor shaft with a small brush.

(3) Preventive Maintenance: In addition to cleaning the seals, an examination should be made periodically to insure that a seal against food is being maintained. With proper care, and depending on use, the seals should last for a year or more. However, they can and should be replaced when wear or erosion is noted or minimally once per year. It is recommended that the seals be replaced by an authorized repair agency.

Good operational performance is obtained when the blades are sharp. Continued use can dull the blades. The blades should be replaced when they become dull.

In general, the best preventive measure that can be applied is close adherence to the assembly and operator's instructions along with common sense.

Your Robot Coupe is a piece of kitchen equipment and like all other kitchen equipment, extreme care and caution should be used when operating. Although training requirements are minimal, only responsible and reasonably prudent individuals should be allowed to operate your machine.

DO NOT allow the machine to run unattended.

DO NOT remove the cutter bowl attachment from the base when the motor is running.

DO NOT put anything other than food objects into the cutter bowl.

DO NOT overload the bowl with food.

DO NOT attempt to loosen any stuck particles without first removing the cutter bowl. It is a good practice to also unplug your unit before attempting any servicing or inspection.

DO NOT immerse the motor base in water.

DO NOT leave the machine ON when it is not processing food.

DO NOT pick up the machine by the bowl or cord, always remove any attachments and lift by the base.

DO NOT operate your machine with missing feet or sitting on a towel or other object. This can block ventilation causing the motor to overheat.

V. TROUBLE SHOOTING AIDS

The following section indicates potential problems and the correct solution which should be implemented by users. Problems which extend beyond these will require an experienced repairman. A list of the authorized service agencies is supplied.

- A. Unit does not start.
 1. Is the bowl tightly in place?
 2. Is the long bowl lid tab fully in place over the handle. Try again.
 3. Press the OFF button and **unplug**.
 4. Try another outlet.
 5. Press the OFF button and **unplug**.
 6. Remove the bowl.
 7. Remove any product from inside the bowl.
 8. Is there any product jamming the blade? If so remove the jam.
- B. Unit stops running while processing.
 1. Turn unit **OFF**
 2. **Unplug**.
 3. Follow A above and try again.
- C. If unit does not operate after following above.
 1. Check outlet for current (breaker or fuse).
 2. Try unit again.
 3. Call local factory authorized service agency.
- D. Unit starts to spark or smoke.
 1. Turn unit off, unplug it, call local factory authorized service agency.

VI. SERVICING OF YOUR ROBOT COUPE

Your Robot Coupe has a one year limited warranty against defects in parts and workmanship. Should the unit require service, check with your distributor to see where local service is available. If not or if you wish your unit to be serviced at the factory, call for a return merchandise authorization (RMA) number, and upon receipt of same, ship it PREPAID and insured to our factory address.

Robot Coupe USA, Inc.
Service Department
Phone: 1-800-824-1646
601-898-8411

Blixer 5 and Blixer 6 Wiring Diagram for USA and Canada

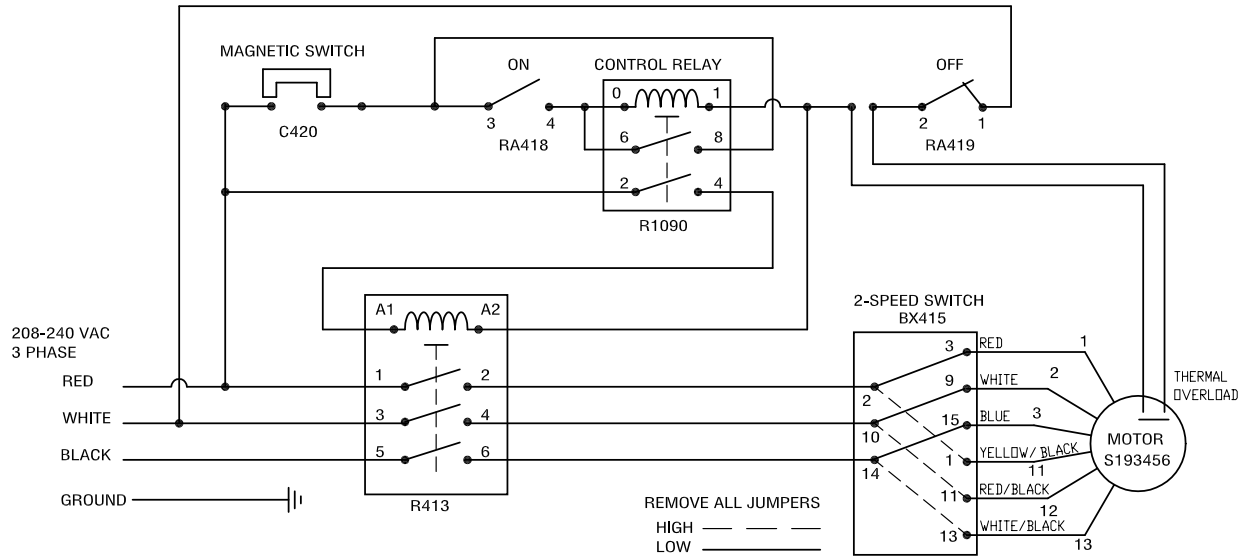

REMOVE ALL JUMPERS

HIGH — — —

LOW — — —

RETIGHTEN LOOSE SCREWS

CORRECT ROTATION

IS COUNTERCLOCKWISE

HIGH AND LOW SPEED

SPEED CONNECTIONS	
LOW	HIGH
SWITCH - MOTOR	SWITCH - MOTOR
3 - 1	1 - 11
9 - 2	11 - 12
15 - 3	13 - 13

Phone: 1-800-824-1646
 Fax: 601-898-9134
 email: info@robotcoupeusa.com

Blixer 5

Serial Numbers 240xxxxx13
 Two Speed, 220 Volt, 3 Phase, 60Hz., 2 HP.
 1725-3450 RPM, 5.3/5.8 Amps

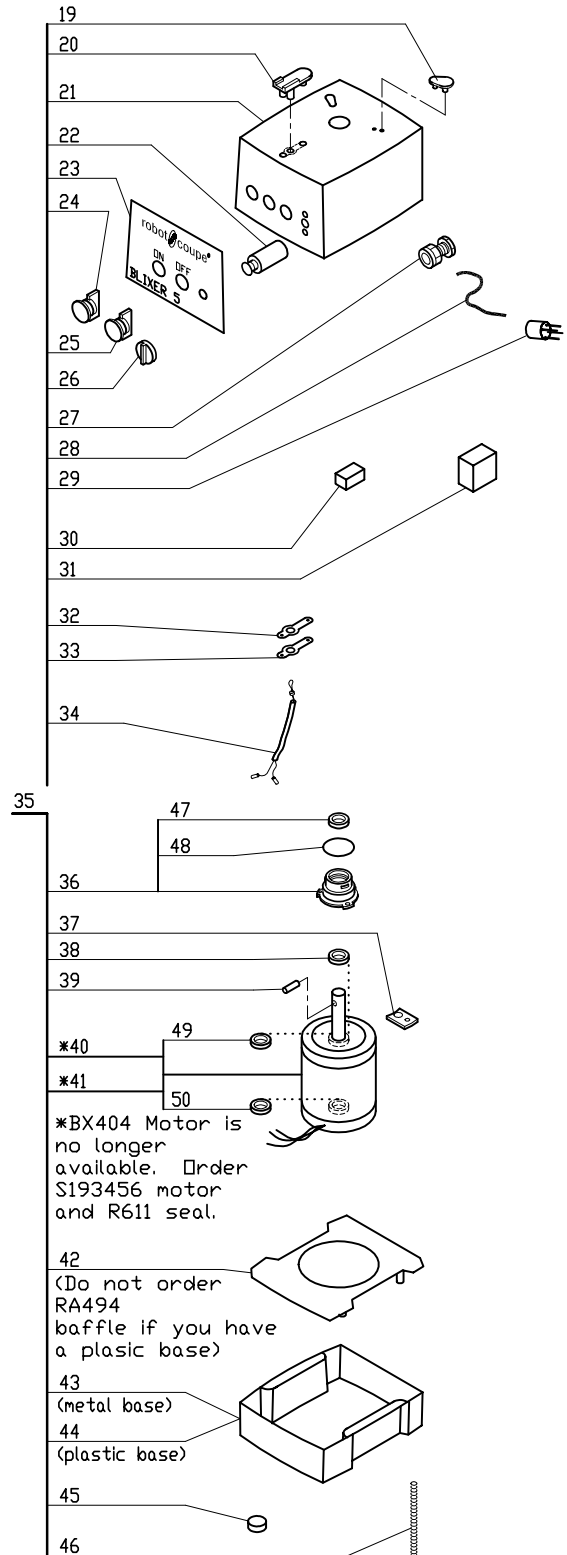
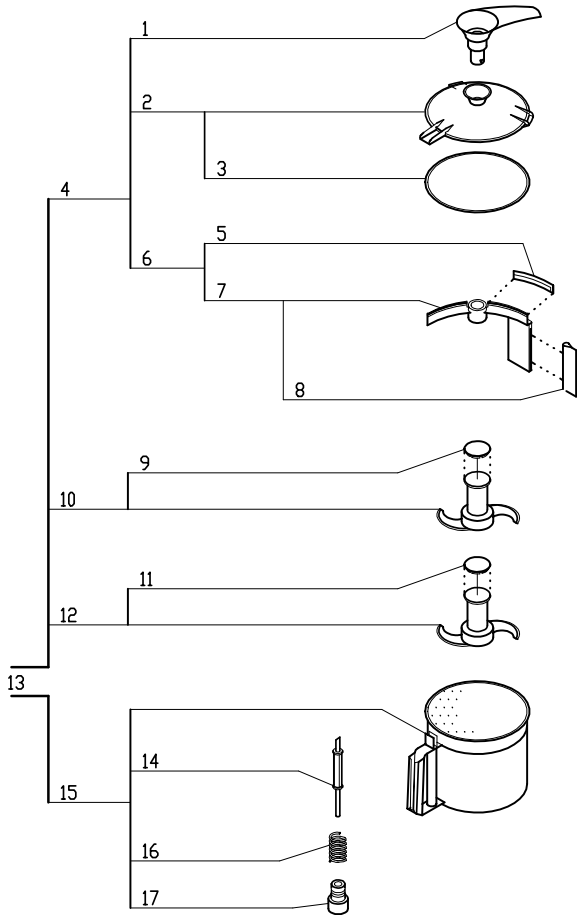
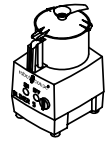

ACCESSORIES

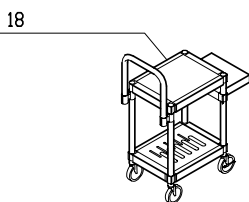

PRICES AND OTHER INFORMATION SUBJECT TO CHANGE WITHOUT NOTICE

MODEL		
Blixer 5		Serial Numbers 240xxxxx13
Indexes	Part #	Description
1	BX620.1	Handle
2	RA420	Lid
3	RA451	Seal,Lid
4	BX421	Lid W/Blade Wiper Assy.
5	BX620.3	Horizontal Wipe Blade
6	BX420	Wipe Blade Holder W/Wipers
7	BX420.4	Wiper Blade Holder W/Vertical Wiper
8	BX420.5	Vertical Wiper
9	BX422.1	Cap
10	BX422	* Blixer Blade(Fine) 4 Quart
11	BX422.1	Cap
12	BX422A	* Blixer Blade (Coarse) 4 Quart
13	BX450	* 4qt. Blixer Bowl Assy
14	RA424.2	Pin, Bowl
15	BX452	Blixer Bowl Only 4 qt.
16	RA424.3	Spring, Bowl Pin
17	RA424.4	Nut For Bowl Pin
18	R199	* Robo-Cart
19	RA443	Pad,Rear
20	RA441	Support/Pad,Front
21	RA406	Motor Support
22	R8U038	Speed Selector Switch
23	408090	Description NA
24	RA418	Green "On" Switch Assy
25	RA419	Red "Stop" Switch Assy
26	RA416	Switch Knob
27	RA490	Strain Relief
28	R403	Cord without Plug
29	R4904	Plug 3 Phase
30	R1090	Control Relay, Run(DPST)
31	R413	Voltage Relay
32	RA441.1	Gasket
33	RA441.2	Metal Plate
34	C420	Mag Swtch w/Hse (single)
35	BX470	BX4 Motor Base Assy
36	RA467	Seal Assembly (Seal Support)
37	RA455	Plate, Motor Mounting
38	R604S	Seal, Motor
39	R492A	Shaft Pin (new style)
40	S193456	(H) Motor BX4/BX6 Low-Profile
41	BX404	No Longer Available
42	RA494	Baffle
43	BX601	Short Base (BX4/BX6)
44	29620	(E) Plastic Base, Low Profile
45	RA402	Foot
46	BX658	Base Bolt W/Washer
47	R611	Motor Support Seal
48	RA489	O Ring, Seal Support
49	R662	Bearing, Motor Top
50	R237	6203 Bearing R2 Top/Btm

Phone: 1-800-824-1646
 Fax: 601-898-9134
 email: info@robotcoupeusa.com

Blixer 6

Serial Numbers 241xxxxx13
 Two Speed, 220 Volt, 3 Phase, 60Hz., 2 HP.
 1725-3450 RPM, 5.3/5.8 Amps

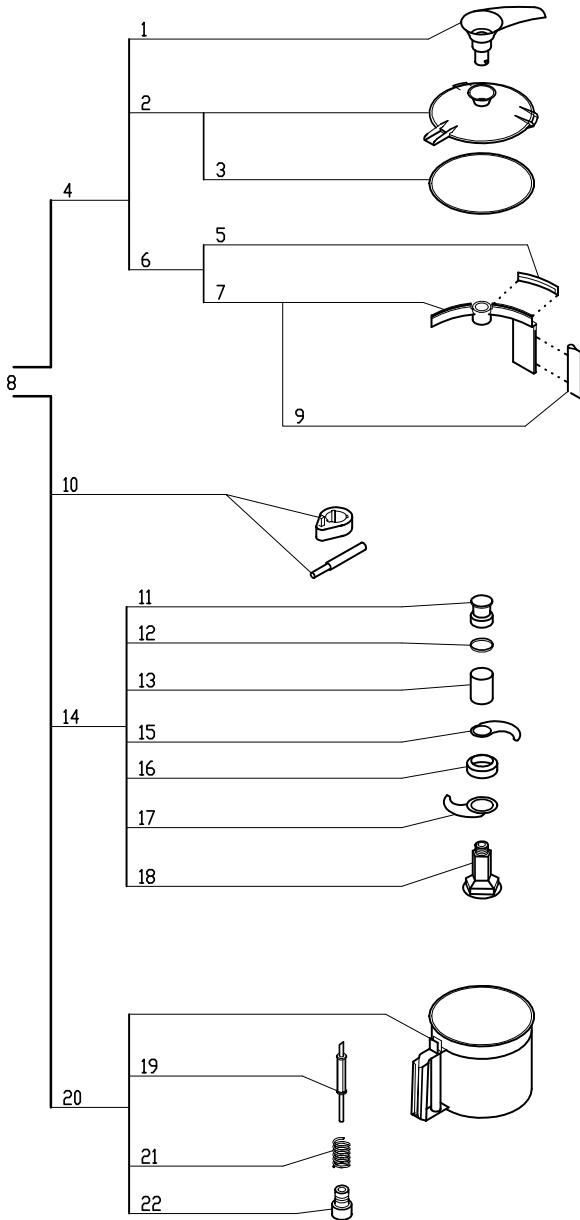
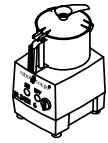

ACCESSORIES

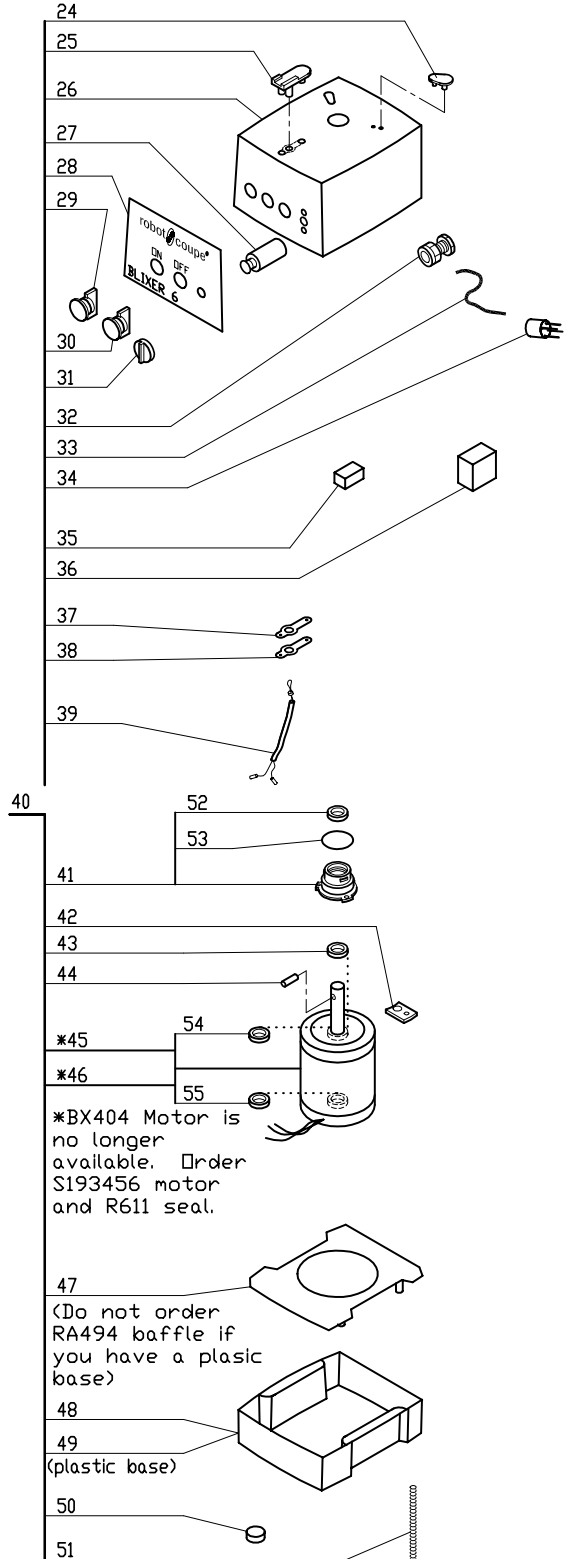
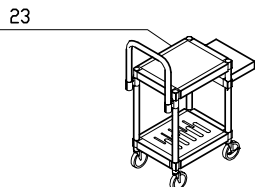

PRICES AND OTHER INFORMATION SUBJECT TO CHANGE WITHOUT NOTICE

MODEL		
Blixer 6		Serial Numbers 241xxxxx13
Indexes	Part #	Description
1	BX620.1	Handle
2	RA420	Lid
3	RA451	Seal,Lid
4	BX621	Lid W/Blade Wiper Assy
5	BX620.3	Horizontal Wipe Blade
6	BX620	Wiper Blade Holder W/Wipers
7	BX620.4	Wiper Blade Holder W/Vertical Wiper
8	BX650	* 6qt Blixer Bowl Assy
9	BX620.5	Vertical Wiper
10	RA616	Blade Tool Assy.
11	BX651.1	Blade Locking Nut
12	BX651.2	5 MM Spacer
13	BX651.3	77 MM Spacer
14	BX651	*Blade Assy.
15	BX651.4	Top Blade
16	BX651.6	26 MM Spacer
17	BX651.5	Bottom Blade
18	BX651.7	Blade Support
19	RA645.2	Pin, Bowl
20	BX652	Blixer Bowl Only 6 qt.
21	RA424.3	Spring, Bowl Pin
22	RA424.4	Nut For Bowl Pin
23	R199	* Robo-Cart
24	RA443	Pad,Rear
25	RA441	Support/Pad,Front
26	RA406	Motor Support
27	R8U038	Speed Selector Switch
28	Number NA	Description NA
29	RA418	Green "On" Switch Assy
30	RA419	Red "Stop" Switch Assy
31	RA416	Switch Knob
32	RA490	Strain Relief
33	R403	Cord without Plug
34	R4904	Plug 3 Phase
35	R1090	Control Relay, Run(DPST)
36	R413	Voltage Relay
37	RA441.1	Gasket
38	RA441.2	Metal Plate
39	C420	Mag Swtch w/Hse (single)
40	BX670	BX6 Motor Base Assy
41	RA467	Seal Assembly (Seal Support)
42	RA455	Plate, Motor Mounting
43	R604S	Seal, Motor
44	R492A	Shaft Pin (new style)
45	S193456	(H) Motor BX4/BX6 Low-Profile
46	BX404	No Longer Available
47	RA494	Baffle
48	BX601	Short Base (BX4/BX6)
49	29620	(E) Plastic Base, Low Profile
50	RA402	Foot
51	BX658	Base Bolt W/Washer
52	R611	Motor Support Seal
53	RA489	O Ring, Seal Support
54	R662	Bearing, Motor Top
55	R237	6203 Bearing R2 Top/Btm

Robot Coupe® *U.S.A., Inc.*

*P.O. Box 16625, Jackson, MS 39236-6625
280 South Perkins St., Ridgeland, MS 39157
email: info@robotcoupeusa.com
website: www.robotcoupeusa.com
1-800-824-1646*

ROBOT COUPE U.S.A., INC. LIMITED WARRANTY

**YOUR NEW ROBOT COUPE PRODUCT IS WARRANTED TO THE ORIGINAL PURCHASER
FOR A PERIOD OF ONE YEAR FROM THE DATE OF PURCHASE**

This LIMITED WARRANTY is against defects in the material and/or workmanship, and includes labor for replacement of defective parts, provided repairs are performed by an authorized service agency (see attached list). The CUSTOMER must inform the Service Agency of the possibility of warranty coverage and provide a copy of the dated sales or delivery receipt BEFORE WARRANTY REPAIRS ARE BEGUN. Replacement parts and accessories are warranted for ninety (90) days from the date of purchase when purchased separately and will be verified by dated sales receipt OR packing slip which list that item. All parts or accessories replaced under warranty must be returned to the Service Agency.

THE FOLLOWING ARE NOT COVERED UNDER WARRANTY.

1. Damage caused by abuse, misuse, dropping, or other similar incidental damage caused by or as result of failure to follow installation, assembly, operating, cleaning, user maintenance or storage instructions, including failure to verify and correct rotation of three phase motors.
2. Labor to sharpen and/or parts to replace knife assemblies or blades which have become dull, chipped, or worn due to normal use.
3. Material or labor to renew or repair scratched, stained, chipped, dented, or discolored surfaces, blades, knives, attachments, or accessories.
4. Transportation charges to or from an authorized service agency for repairs of a machine designated as "CARRY IN SERVICE" (Table Top Models).
5. Labor charges to install or test attachments or accessories (i.e. bowls, cutting plates, blades, attachments) which are replaced for any reason.
6. Charges to change Direction-of-Rotation of Three Phase electric motors (INSTALLER IS RESPONSIBLE). All Robot Coupe products must operate counter-clock-wise.
7. SHIPPING DAMAGE IS NOT COVERED BY WARRANTY. Visible and hidden damages are the responsibility or the freight carrier. The consignee must file a damage claim promptly against the carrier, or upon discovery in the case of hidden damage.

**KEEP ALL ORIGINAL CONTAINERS AND PACKING MATERIALS
FOR CARRIER INSPECTION**

Robot Coupe U.S.A., Inc., Robot Coupe S.A., or any of their affiliates, distributors, officers, directors, agents, employees or insurers will not be obligated for consequential or other damages, losses, or expenses in connection with or by reason of the use of or the inability to use the machine for any purpose.

THIS WARRANTY IS GIVEN EXPRESSLY AND IN LIEU OF ALL OTHER WARRANTIES EXPRESSED OR IMPLIED, FOR MERCHANTABILITY AND FOR FITNESS TOWARD A PARTICULAR PURPOSE AND CONSTITUTES THE ONLY WARRANTY MADE BY ROBOT COUPE, U.S.A., Inc.